

2022

# 3 SERIES *isata*



DIFFERENT BY DESIGN

## DÉCOR SELECTIONS

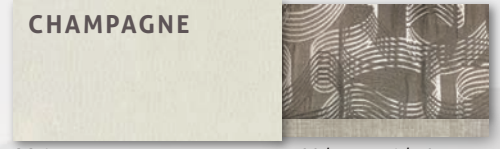

Main Valance with Accent



Main Valance with Accent

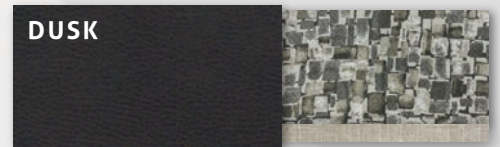

Main Valance with Accent

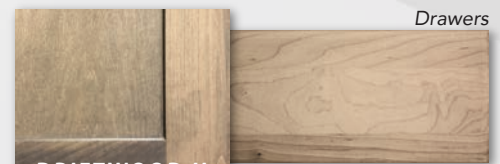

Drawers Flooring



Drawers

Dimensions:	24FW	24RW
GVWR	11,030 lbs.	11,030 lbs.
GCWR	15,250 lbs.	15,250 lbs.
GAWR - Front	4,410 lbs.	4,410 lbs.
GAWR - Rear	7,720 lbs.	7,720 lbs.
UVW*	10,054 lbs.	10,155 lbs.
Overall Length	24' 7"	24' 7"
Exterior Width	94"	94"
Wheelbase	170"	170"
Overall Exterior Height	11' 5"	11' 5"
Interior Height	81"	81"
Fuel Capacity	26.4 Gal.	26.4 Gal.
Water Capacities (Gal.)		
Fresh/Gray/Black	35/32/32	35/32/32
LPG Capacity (WC)	20.3 Gal.	20.3 Gal.
Awning Length	16'	16'

\*UVW is an estimate only based on standard equipment.

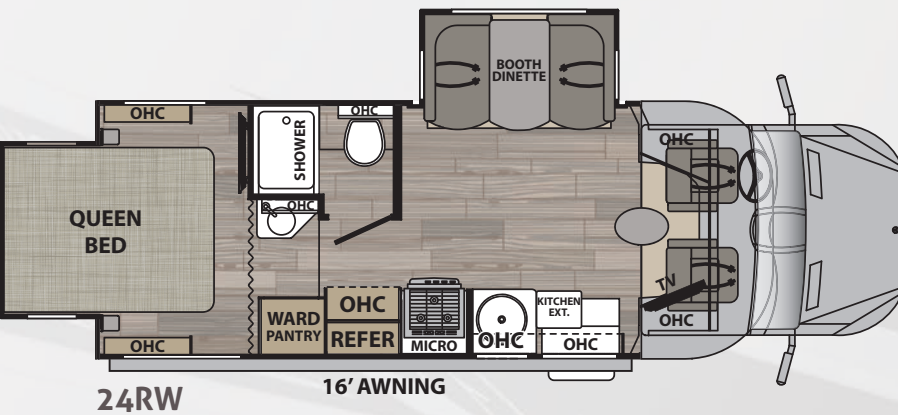
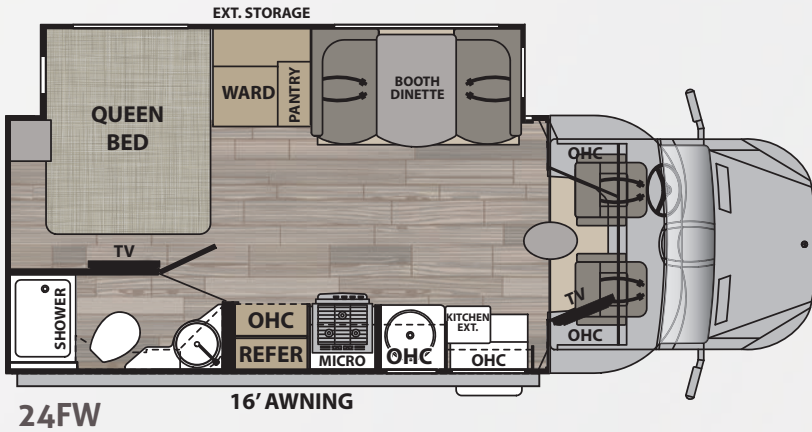

## ISATA 3 OPTIONS

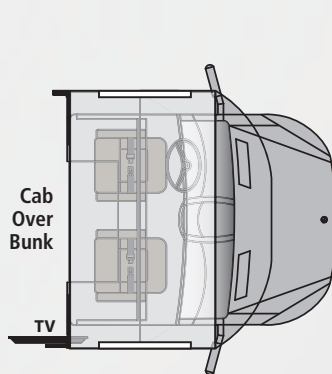

Dual Power Recliners IPO Dinette (24RW)

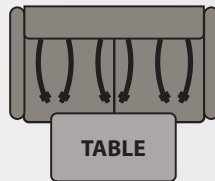

Tri-Fold Sofa with Table IPO Dinette



3 Seat Power Recliner IPO Dinette (24FW)  
Middle Seat is Manual Recline

**GVWR (Gross Vehicle Weight Rating)** - is the maximum permissible weight of the unit when fully loaded. It includes all weights, inclusive of all fluids, occupants, cargo, optional equipment and accessories. For safety and product performance do NOT exceed the GVWR.

**GCWR (Gross Combined Weight Rating)** - is the maximum permissible loaded weight of your motorhome and any towed trailer or towed vehicle. Actual GCWR of this vehicle may be limited by the sum of the GVWR and the installed hitch receiver maximum capacity rating; see hitch rating label for detail.

**GAWR (Gross Axle Weight Rating)** - is the maximum permissible weight, including cargo, fluids, optional equipment and accessories that can be safely supported by each axle.

**UVW (Unloaded Vehicle Weight)**\* - is the typical weight of the unit as manufactured at the factory. It includes all weight at the unit's axle(s), including full fuel, all fluids and LP Gas. The UVW does not include cargo, fresh potable water, additional optional equipment or dealer installed accessories.

\*Estimated Average based on standard build optional equipment.

**CCC (Cargo Carrying Capacity)\*\*** - is the amount of weight available for fresh potable water, cargo, passengers, additional optional equipment and accessories. CCC is equal to GVWR minus UVW. Available CCC should accommodate fresh potable water (8.3 lbs per gallon). Before filling the fresh water tank, empty the black and gray tanks to provide for more cargo capacity.

\*\*Estimated average based on standard build optional equipment.

Each Forest River RV is weighed at the manufacturing facility prior to shipping. A label identifying the unloaded vehicle weight of the actual unit and the cargo carrying capacity is applied to every Forest River RV prior to leaving our facilities.

The load capacity of your unit is designed by weight, not by volume, so you cannot necessarily use all available space when loading your unit.

Actual towing capacity is dependent upon your particular loading and towing circumstances, which includes the GVWR, GAWR and GCWR as well as adequate trailer brakes. Please refer to the Operator's Manual of your vehicle for further towing information.

### CHASSIS

- Mercedes-Benz® Sprinter Chassis
- 3.0L V6 Turbo Diesel Engine (188 hp / 325 lb-ft. of Torque)
- 7G-TRONIC PLUS Automatic Transmission with Overdrive
- 26.4-Gallon Fuel Tank
- 5.75-Gallon Diesel Exhaust Fluid Tank
- Lane Keep Assist
- Adaptive Cruise Control
- Active Brake Assist
- High-Beam Assist
- Crosswind Assist
- Attention Assist
- Traffic Sign Assist
- Rescue Assist
- Electronic Stability Program (ESP)
- Wet Wiper System
- Trailer Hitch (5,000 Tow lbs.) with 7-Way Round Tow Connection
- Momentary Battery Booster Switch for Connecting Chassis and House Batteries
- Single 12V Chassis Battery
- 220-Amp Alternator
- LED Brake, Turn, and Backup Lights
- Aluminum Running Boards
- Bilstein® Gas-Charged Rear Shock Absorbers
- Aluminum Wheels (Set of Four) with Metal Valve Extensions
- Front and Rear Tires: LT215/85 R16
- Single Front Wheels and Dual Rear Wheels (5.5" x 16")
- 4.18 Rear Axle Ratio
- Power, Heated Leatherette Cab Seats with Swivel Bases
- Upgraded Multifunction Steering Wheel
- Upgraded Instrument Cluster with Pixel-Matrix Display
- Quad-View Camera System (Right Side, Left Side, Hitch, and Rear Horizon Views)
- MBUX (Mercedes-Benz User Experience) 10.25" Touch Screen Infotainment System with Navigation, AM/FM, Bluetooth®, Sirius / XM® (tuner and antenna), Apple® CarPlay™ / Android® Auto™ Functionality, and "Hey Mercedes" Voice Control
- 12V and USB Accessory Ports
- Adjustable Steering Column
- Power Windows and Locks
- Power Exterior Mirrors (Auto-Heated at Low Temperatures)
- 3-Point Seat Belts
- Front, Thorax, and Window Safety Air Bags
- Lockable Safe in Passenger Seat Base
- Deluxe, Removable Automotive Cab Carpet Mat
- Drink Holders

### CONSTRUCTION

- 1 1/2" Aluminum-Framed, Laminated Sidewalls with Block Foam Insulation
- Gel-Coat Fiberglass Walls with Azdel® Backing
- Aluminum-Framed Floor
- Composite Flooring Substrate (Lightweight and Moisture Resistant)
- Aluminum-Framed Roof Trusses
- Crowned, One-Piece Fiberglass Roof
- Fiberglass Rear Bumper
- Foil-Lined Ductwork Throughout
- Aerodynamic Fiberglass Front Wing Panels
- Aerodynamic Fiberglass Front Cap with Cab-Over Cabinets

- Automatic, 4-Point Hydraulic Leveling Jacks with Bluetooth® Smart Phone App Control
- Dark-Tinted, Frameless Windows
- Seamless Rotocast Storage Compartments with LED Lighting
- Locking Aluminum Exterior Storage Doors with Compression Latches
- Electric Slide System

### EXTERIOR

- Custom Full Body Paint Package
- Premium Cut and Buffed Paint Finish
- Front-End Diamond Shield® Paint Protection
- Dual-Pitch, Armless Patio Awning with LED Lighting and Motion-Activated Retraction
- Slideout Topper(s)
- LED Patio Light
- Entry Door with Dark-Tinted, Frameless Window and Integrated Shade
- Lighted Acrylic Entry Grab Handle
- Power Entry Step
- Exterior TV Mount
- Exterior Speakers
- Front and Rear LED Clearance and Marker Lighting

### INTERIOR

- Premium Vinyl Flooring Throughout
- Soft-Touch Padded Vinyl Ceiling
- LED Flush-Mount Ceiling Lighting
- Sprung, Residential-Style Dinette Seats with Lift Up Storage
- Coordinating Window Treatments
- Blackout Roller Shades (Steel Blind at Kitchen Window)
- Hardwood Craftsman-Style Cabinetry
- Full Extension, Soft-Closing Drawer Guides (where applicable)
- Hidden Hinges
- 32" LED Smart TV (Living Area)
- Stereo System - AM/FM with Zoned Speaker Control and Bluetooth® Smart Phone App Control
- Easy Access Battery Compartment Beneath Entry Step
- Entry with Non-Skid Rubber Step and Steel Risers
- Thermal, Reflective Front Privacy Shades
- USB Charging Ports
- Cocktail Table Between Cab Seats
- Cab Seat Booster Cushions (Set of Two)

### KITCHEN

- 6.0 cu. ft. 2-Way Refrigerator (Double-Door)
- Gas Range with Glass Cover and Overhead Range Cover
- Convection Microwave Oven
- Solid Surface Countertops with LED Edge Lighting and Backsplash
- Solid Surface Countertop Extension
- Stainless Steel Sink with Solid Surface Cover
- Residential Stainless Steel Spring Gooseneck Faucet
- Under-Cabinet Lighting
- MaxxAir® Power Vent with Built-In Rain Cover

### BEDROOM

- Queen Bed (60"x75") with Gel-Infused Memory Foam Mattress
- Under-Bed Storage (24FW)
- Deluxe Padded Headboard (24RW)
- Designer Bedding Package
- 32" LED Smart TV
- Cedar-Lined Wardrobe

- LED Reading Lights
- USB Charging Ports
- Privacy Partition

### BATHROOM

- Shower with Light-Weight, Soft-Sided Shower Door and Skylight
- Oxygenics Body Spa® RV Shower Head
- Stainless Steel Sink with Residential Faucet
- Composite Foot-Flush Toilet with Hand Sprayer
- MaxxAir® Power Vent with Built-In Rain Cover

### UTILITIES

- Dual 12V Group 27 AGM Deep-Cycle, Maintenance-Free Auxiliary Batteries
- Firefly® Multiplex Wiring with Touch Screen Command Center, Switch Panels, and Bluetooth® Smart Phone App Control
- Battery Disconnect at Entry
- 30-Amp Service
- 2,000W Pure Sine Wave Inverter (3,300 Peak Watts)
- 3.6kW Onan® LP Generator with Auto Transfer Switch (Mounted on Isolator Pads)
- Automatic Generator Start
- Solar Panels - Two 100 Watt with 30 Amp Controller
- Ducted, Low-Profile 15,000-BTU Air Conditioner with Heat Pump
- 20,000-BTU Furnace with Electronic Ignition
- 60,000-BTU Truma® Aqua Go Comfort™ On-Demand Water Heater (LP)
- 20.3-Gallon LP Tank (WC)
- LP Quick Connect
- Water Filtration System
- Exterior Shower in Service Bay
- Exterior GFCI Receptacle
- Winegard® AIR 360+™ with Gateway Router (WiFi Extender, 4G LTE, Omnidirectional VHF/UHF OTA, FM, SIM Card Port)
- 4x4 HDMI Matrix
- Cable TV/Satellite Hookup
- 60-Amp Progressive Dynamics Converter with Charge Wizard® System
- Black Tank Flush
- TruTank® Level Monitoring (Measures in 5% Increments)
- 12V Heat Pads on Fresh, Gray, and Black Tanks
- Water Management Valve for Fill and Winterizing
- Upgraded 12V On-Demand Water Pump (4 gallons per minute)
- Carbon-Monoxide, LP, and Smoke Detectors
- Fire Extinguisher

### OPTIONS

- Low-Temp Lithium (200Ah) in place of AGM Batteries (-66 lbs.)
- Extended Fiberglass Front Cap with 54"x80" Cab-Over Bunk Mattress and Privacy Curtain (+179 lbs.)
- Dual, Power Reclining Theater Seats in Place of Dinette (+40 lbs.)
- Tri-fold Sofa with Pedestal Table in Place of Dinette (+23 lbs.)
- Winegard® In-Motion T4 Satellite (Dish® SD-HD, DirecTV® SD, BellTV® SD-HD) (+10 lbs.)
- 3.2kW Onan® Diesel Generator in Place of Standard 3.6kW LP (+27 lbs.)
- Tire Pressure Monitoring System with Metal Valve Extensions (+5 lbs.)



A DIVISION OF FOREST RIVER  
DIFFERENT BY DESIGN  
2745 Northland Dr. ■ Elkhart IN 46514  
888-295-7859 ■ www.dynamaxcorp.com

#### Factory Video Tour

<https://www.youtube.com/watch?v=q5cG43PD75E>

#### Paint Video

<https://www.youtube.com/watch?v=sLgLoR26jfs>



All information contained in this brochure is believed to be accurate at the time of publication. However, during the model year, it may be necessary to make revisions and Forest River, Inc., reserves the right to make all such changes without notice, including prices, colors, materials, equipment and specifications as well as the addition of new models and the discontinuance of models shown in this brochure. Therefore, please consult with your Forest River dealer and confirm the existence of any materials, design or specifications that are material to your purchase decision. ©2021 Dynamax, a Division of Forest River, Inc., a Berkshire Hathaway company. All Rights Reserved. 9/21